

Product Highlights

- Spring Loaded
- Standard Vacuum settings - 100 mbarg to - 0.8 barg
- Size range 2" (50 mm) - 12" (300 mm)
- Side Mounted Flange Option
- Standard body materials - Aluminium, Carbon steel, Stainless steel
- Standard trim material - Stainless steel
- Diaphragm material - PTFE
- Removable seats
- Standard full form flanges - ANSI / DIN / JIS / Specials
- Lightweight design
- Steam Jackets
- Proximity Switches to indicate pallet lift
- Tri clamp / screwed connections available
- Alternative materials for hazardous applications
- Non standard applications consult factory

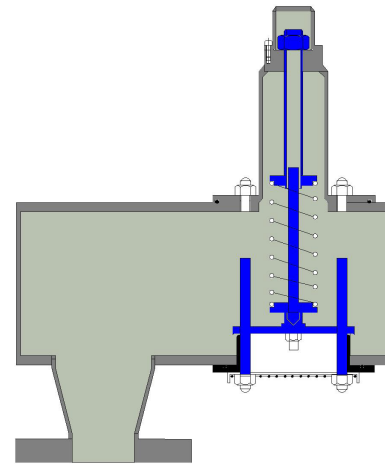

B200S

Features

Low cost maintenance

Lightweight design provides easy handling whilst interchangeable components ensure standard parts are easily replaced

Testing / Quality

All products are factory tested and fully certified.

Self Draining

All products are designed so that any condensate drains away from seating areas.

Low leakage

Standard seating design ensures minimum leakage of less than 1 scfh at 90% of set pressure.

Internal Parts

Internal parts are stainless steel as standard. Non standard materials available upon request.

Connections

All valves are supplied with full form flanges to meet individual requirements. Other connections are available upon request.

Non Standard Applications

There are numerous options available for special applications. Exotic materials such as Hastelloy and various plastics can be offered to suit the most hazardous of environments. Special coatings can be applied for extreme service. For low temperature duties, internal parts can be PTFE coated to prevent seizure.

See separate section in catalogue.

* All products are subject to continuous development and subsequently 3B Controls reserve the right to change specifications outlined in this catalogue without notification.

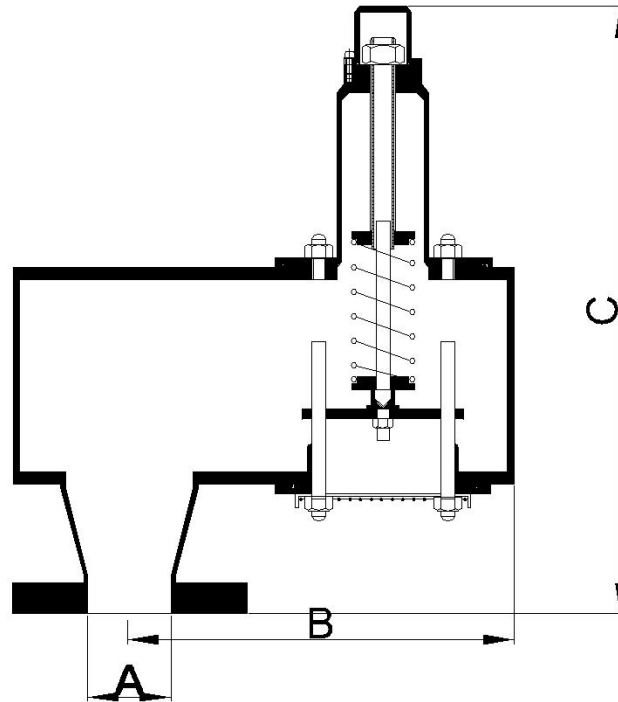

Dimensions

NOM SIZE	A	B	C
50(2")	54	252	460
80(3")	84	308	520
100(4")	108	355	560
150(6")	161	516	620
200(8")	211	626	622
250(10")	255	701	725
300(12")	305	741	725

B200 Series Spring Vacuum Relief Valves

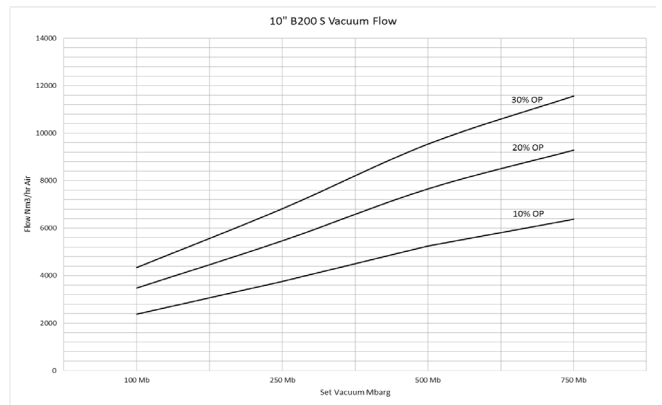
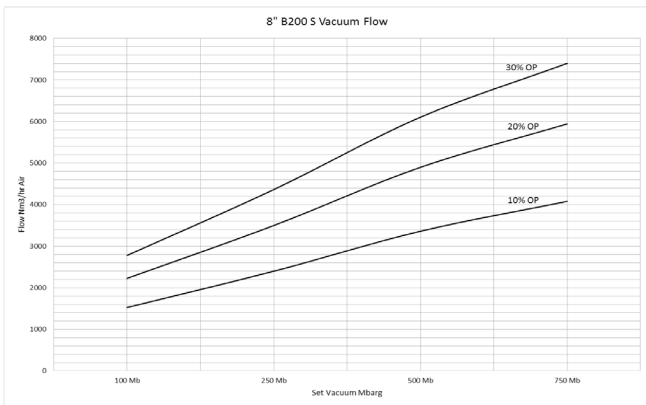
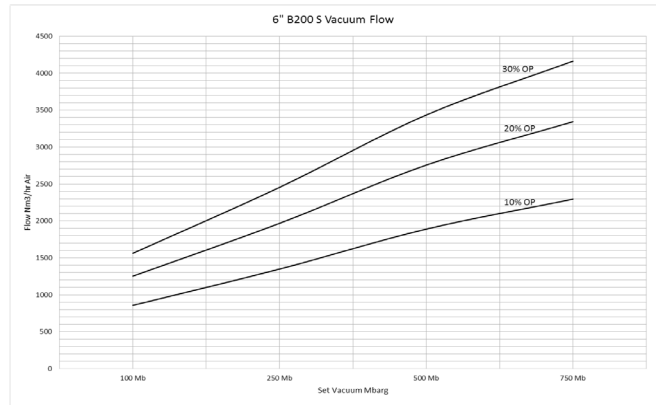
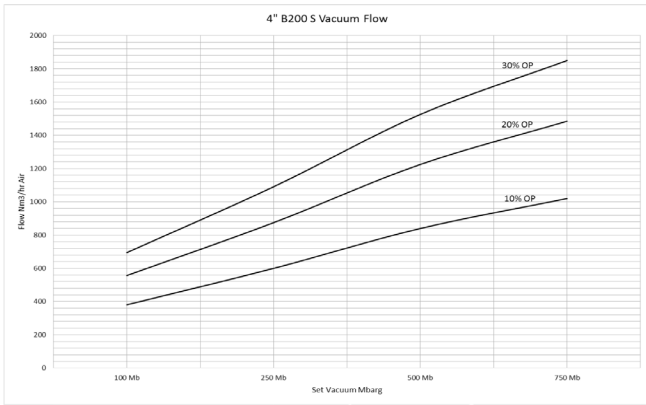
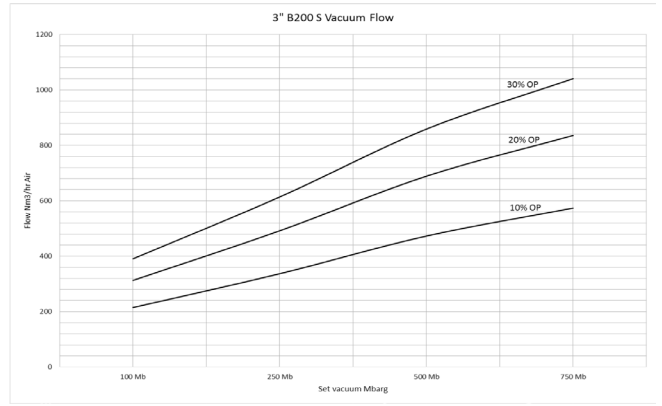
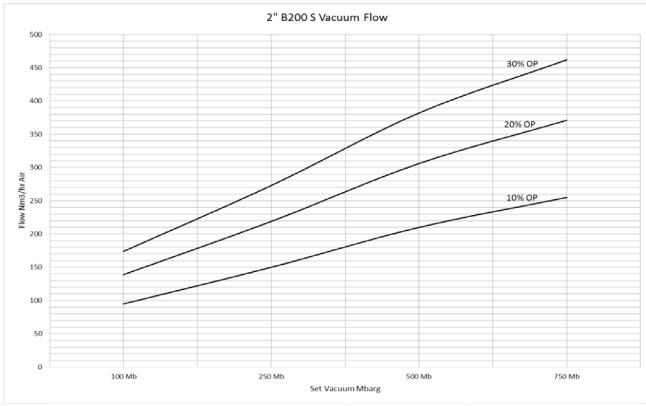

B200 Series Spring Vacuum Relief Valves

